



Tel..

Firma / zákazník

Popis projektu

Číslo výkresu

Komise

ČOV LIBAVÁ

Výrobce (firma)

Cesta

Název projektu

Výrobek

Typ

Místo instalace

Osoba odpovědná za projekt

Zvláštnost dílu

ČOV LIBAVA

Vytvořeno dne 24.11.2014

Zpracováno dne 24.11.2014

od (zkratka) Luděk

Počet stran 29

Datum 24.11.2014

Zprac.. Luděk

Zkontr.

Pův.

ČOV LIBAVÁ

Náhrada z

Nahrazeno čím

Titulní strana

=

+

List 0

List 29

Změna Datum Název

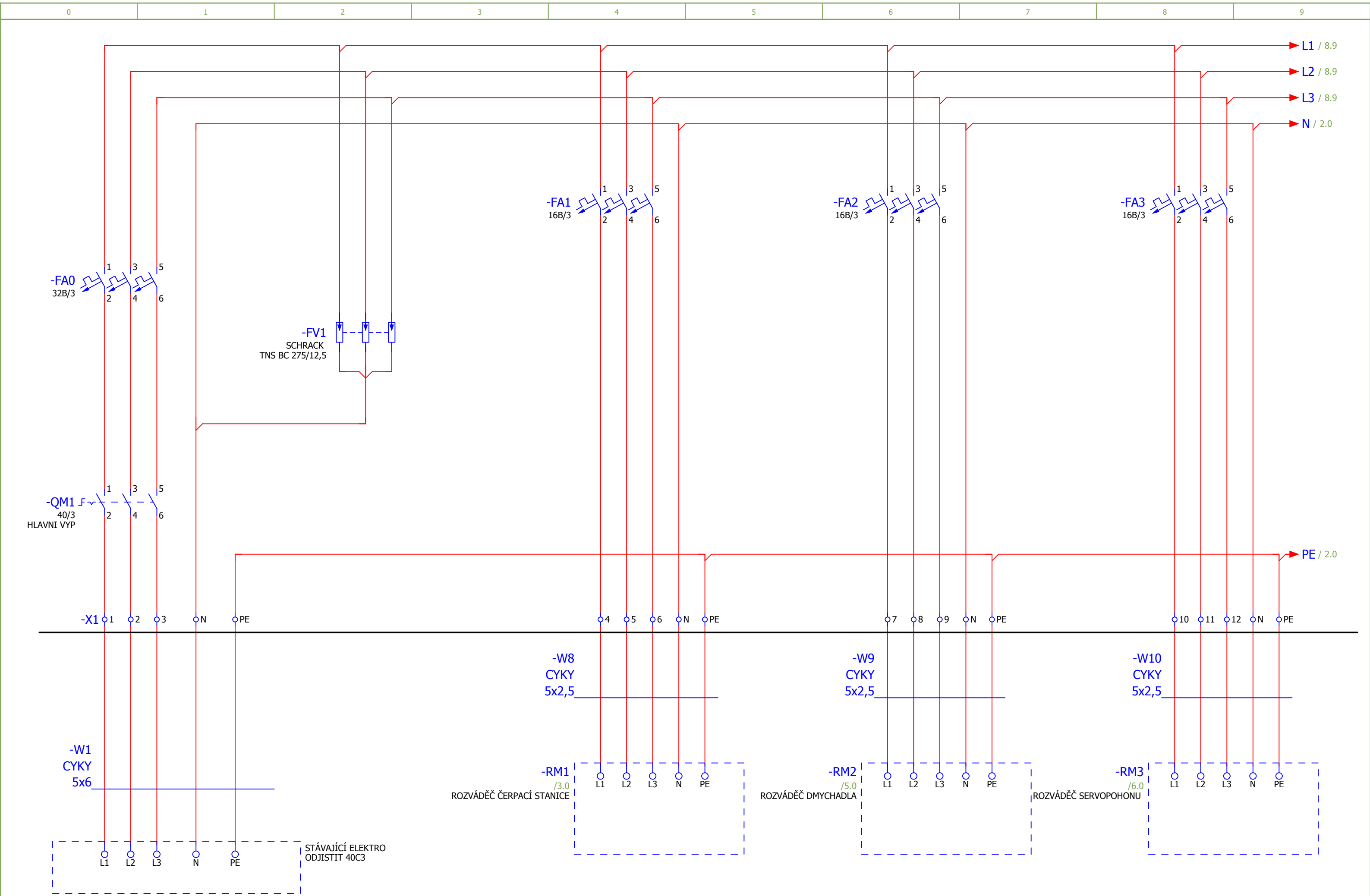

			Datum	24.11.2014								
			Zprac.	Luděk								
			Zkontr.		ČOV LIBAVÁ		ROZVÁDEČ RH					
Změna	Datum	Název	Pův.		Náhrada z	Nahrazeno čím					List	1
											List	29

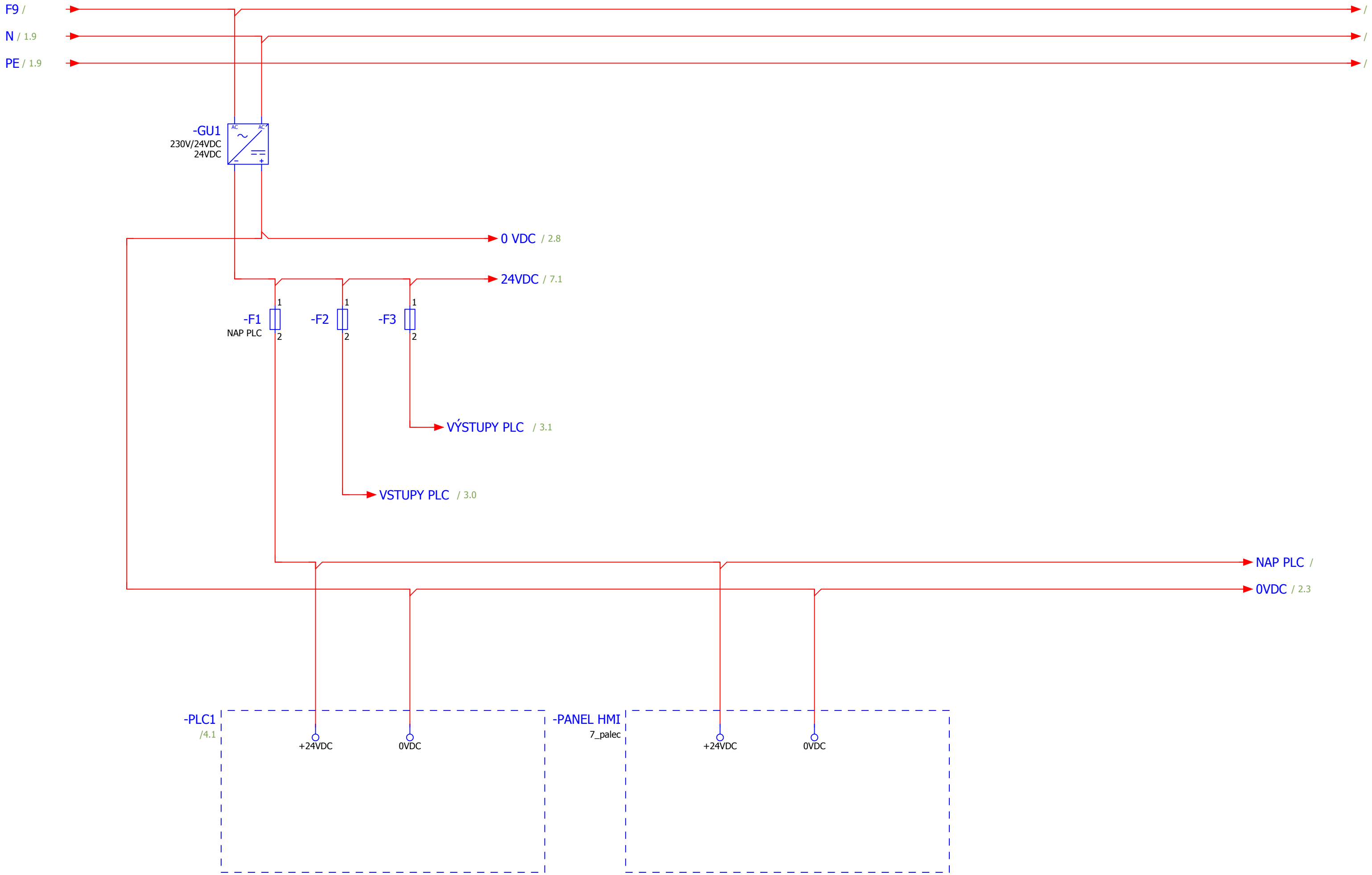

		Datum	24.11.2014			ROZVADEČ RH_2				=	
		Zprac..	Luděk							+	
		Zkontr.		ČOV LIBAVÁ						List	2
Změna	Datum	Název	Pův.	Náhrada z	Nahrazeno čím					List	29

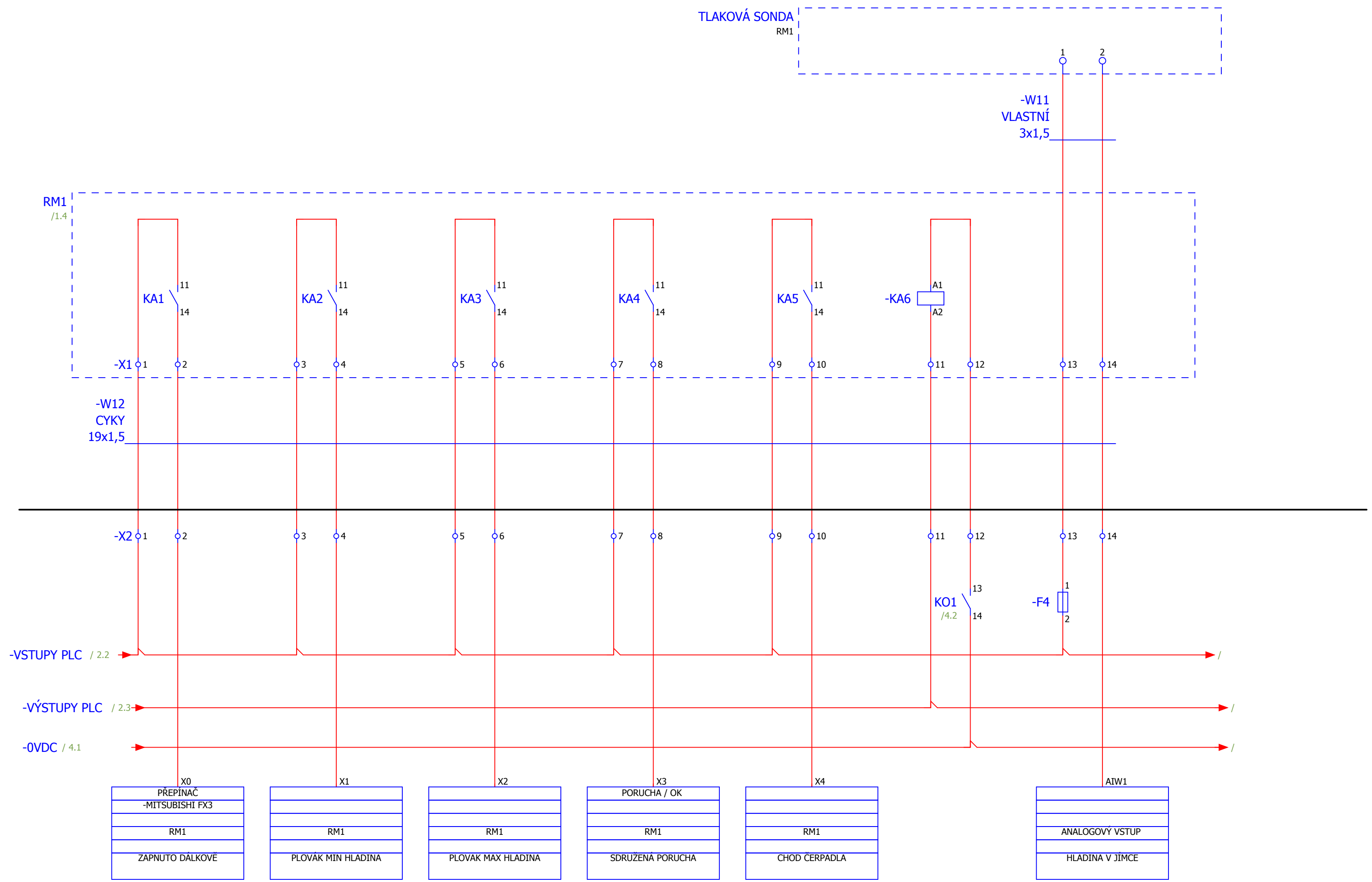

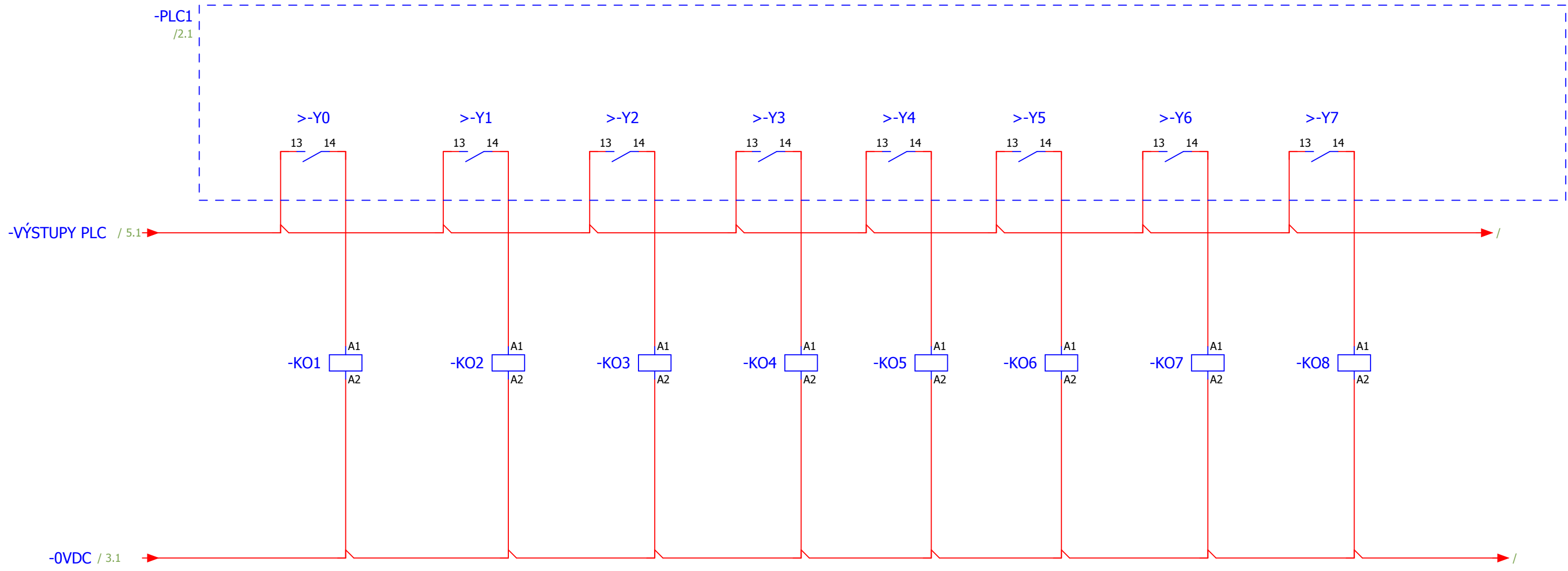

13 - 14 /3.7 13 - 14 /5.7 13 - 14 /6.6 13 - 14 /6.7 13 - 14 /7.3 13 - 14 /7.4

3				5			
Datum	24.11.2014	ČOV LIBAVÁ		ROZVADEČ RH_PLC VÝSTUPY		=	
Zprac.	Luděk					+	
Zkontr.							List 4
Změna	Datum	Název	Pův.	Náhrada z	Nahrazeno čím		List 29

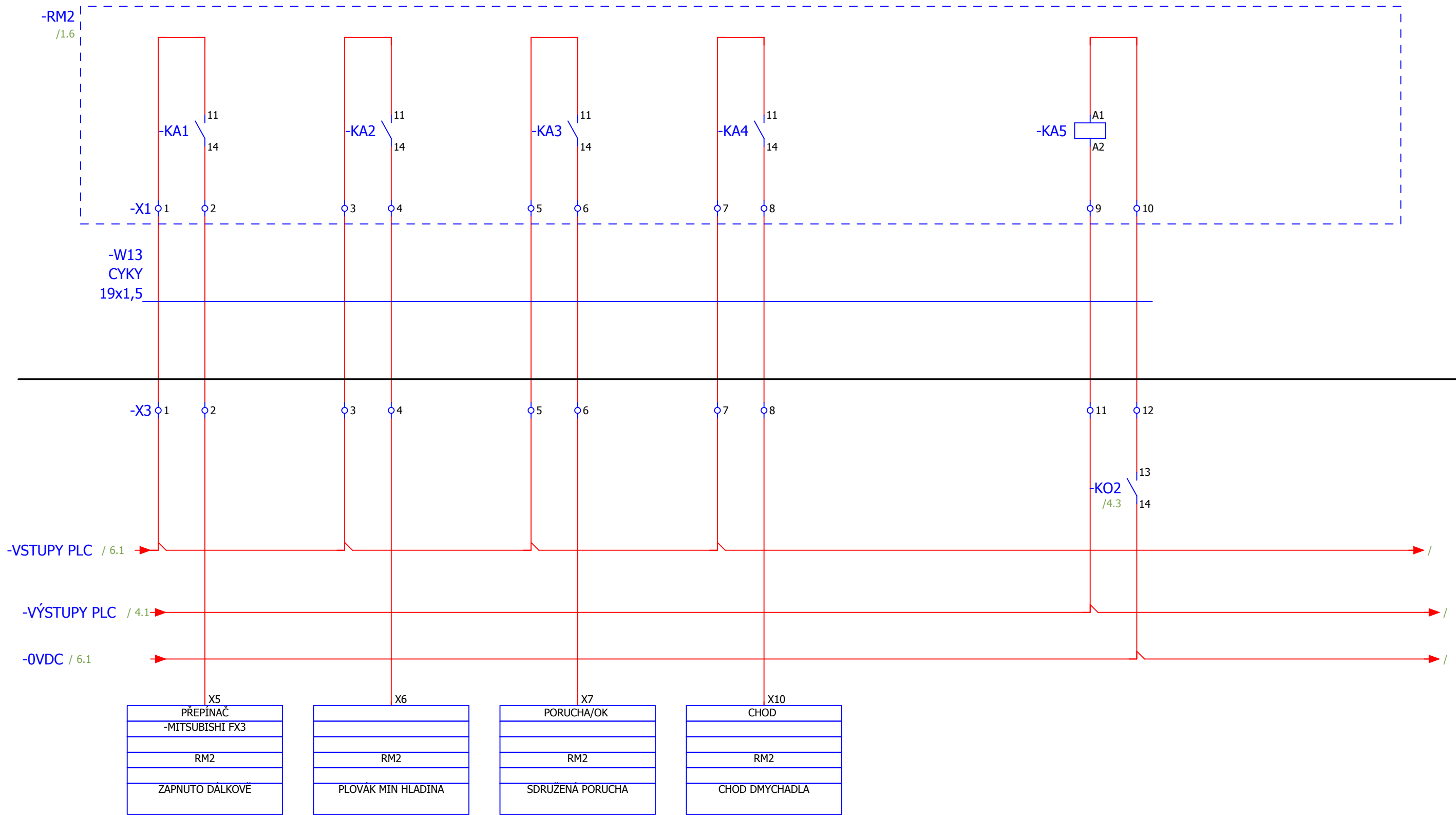

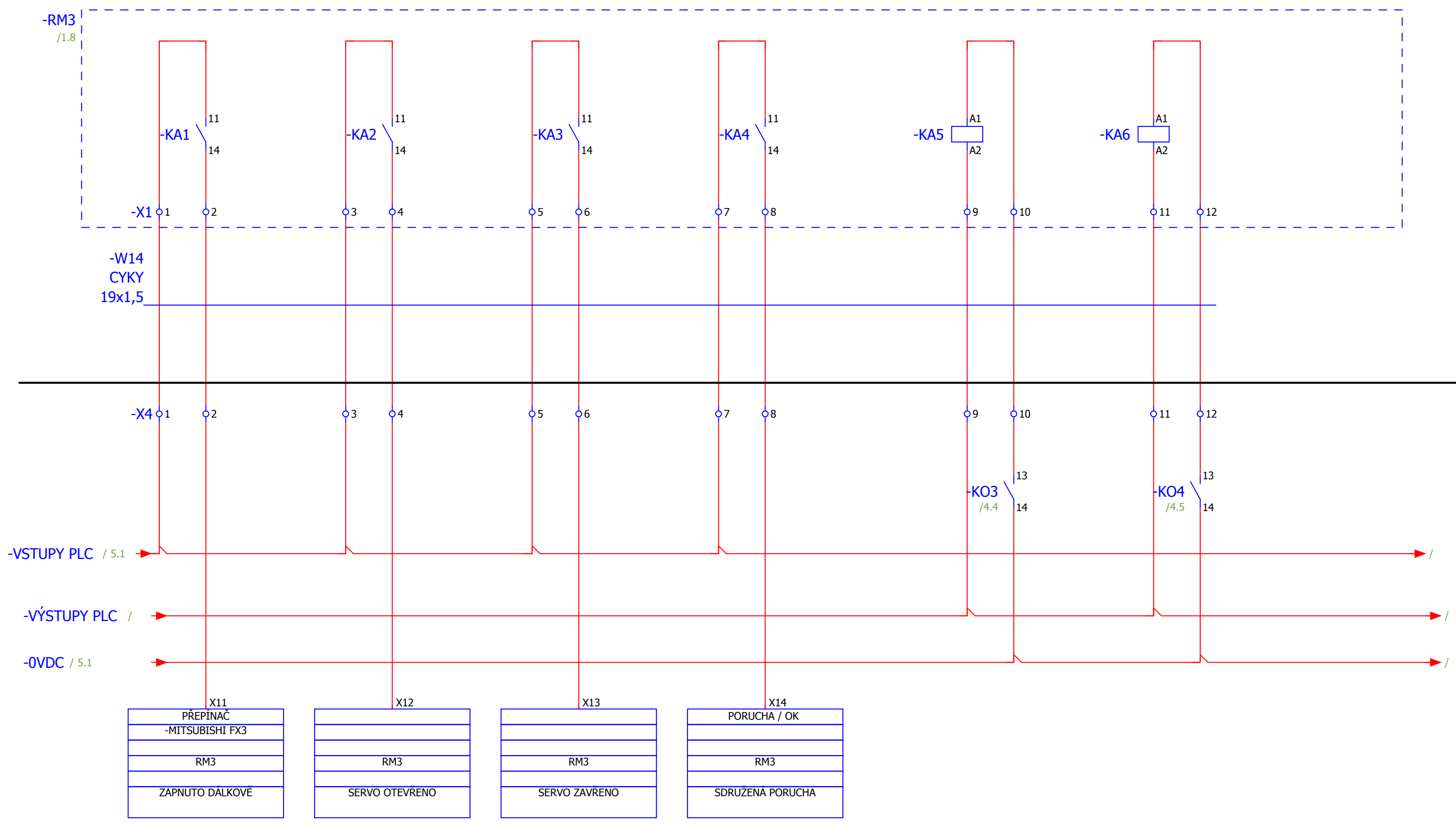

Datum	24.11.2014	ČOV LIBAVÁ	ROZVADEČ RH_PLC VSTUPY/VÝSTUPY RM3	=	List 6		
Zprac..	Luděk					+	List 29
Zkontr.							
Změna	Datum	Název	Pův.	Náhrada z	Nahrazeno čím		

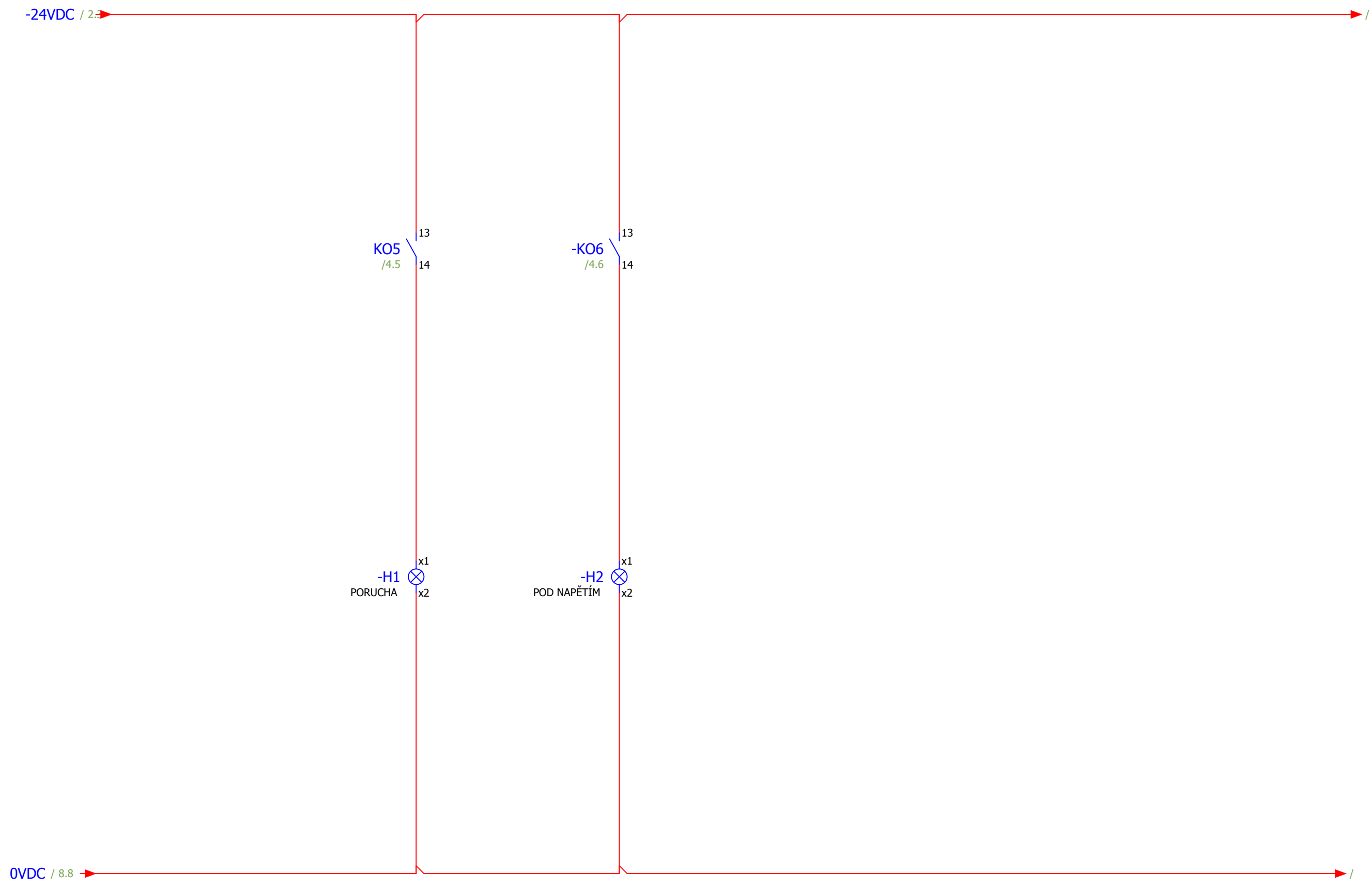

			Datum	24.11.2014					=
			Zprac.	Luděk					+
			Zkontr.		ČOV LIBAVÁ				
Změna	Datum	Název	Pův.		Náhrada z	Nahrazeno čím			List 7
									List 29

ROZVADEČ RH_OVLADAČKA

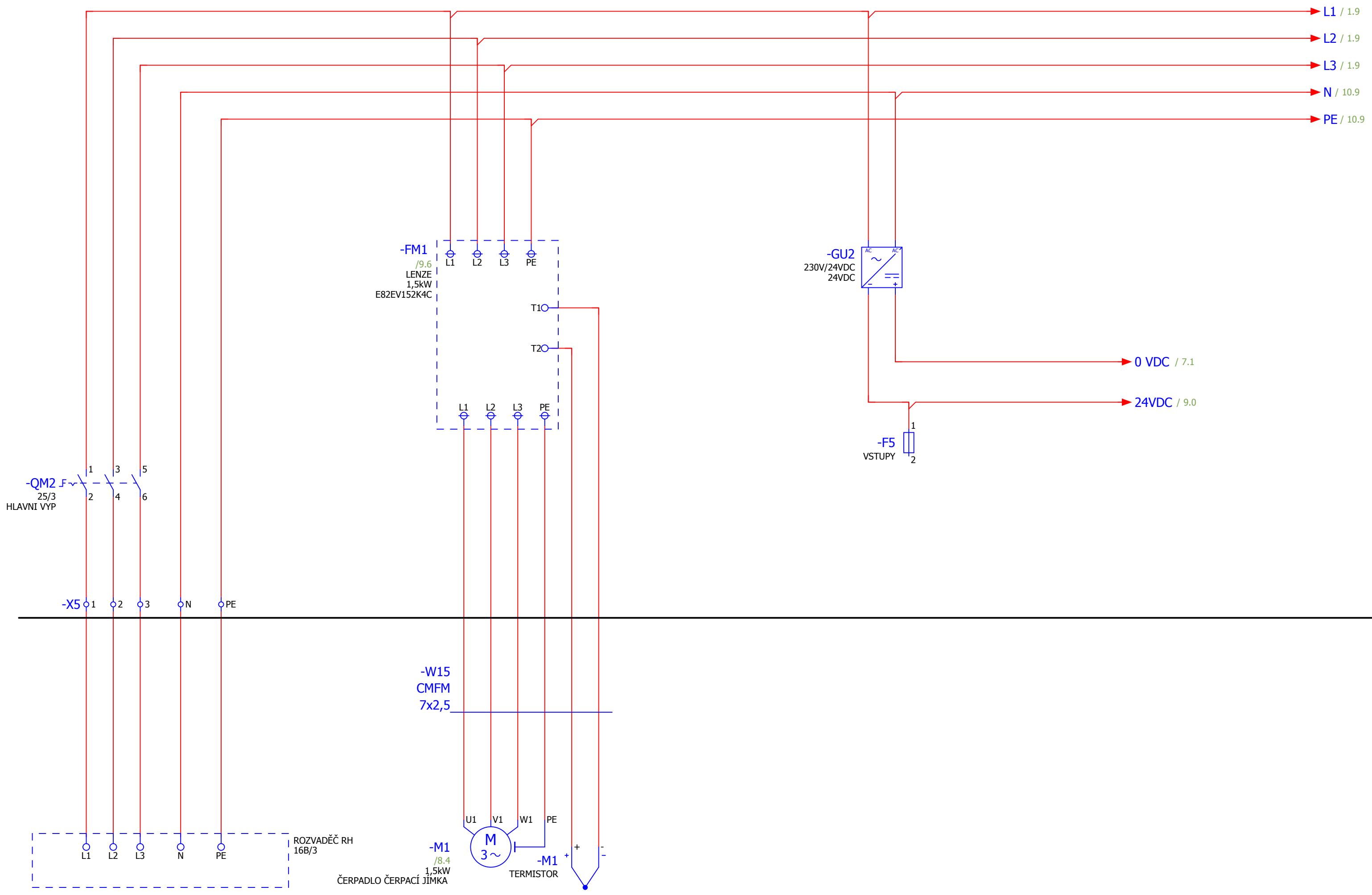

				Datum	24.11.2014					=	
				Zprac..	Luděk					+	
				Zkontr.		ČOV LIBAVÁ				List	8
Změna	Datum	Název	Pův.	Náhrada z	Nahrazeno čím					List	29

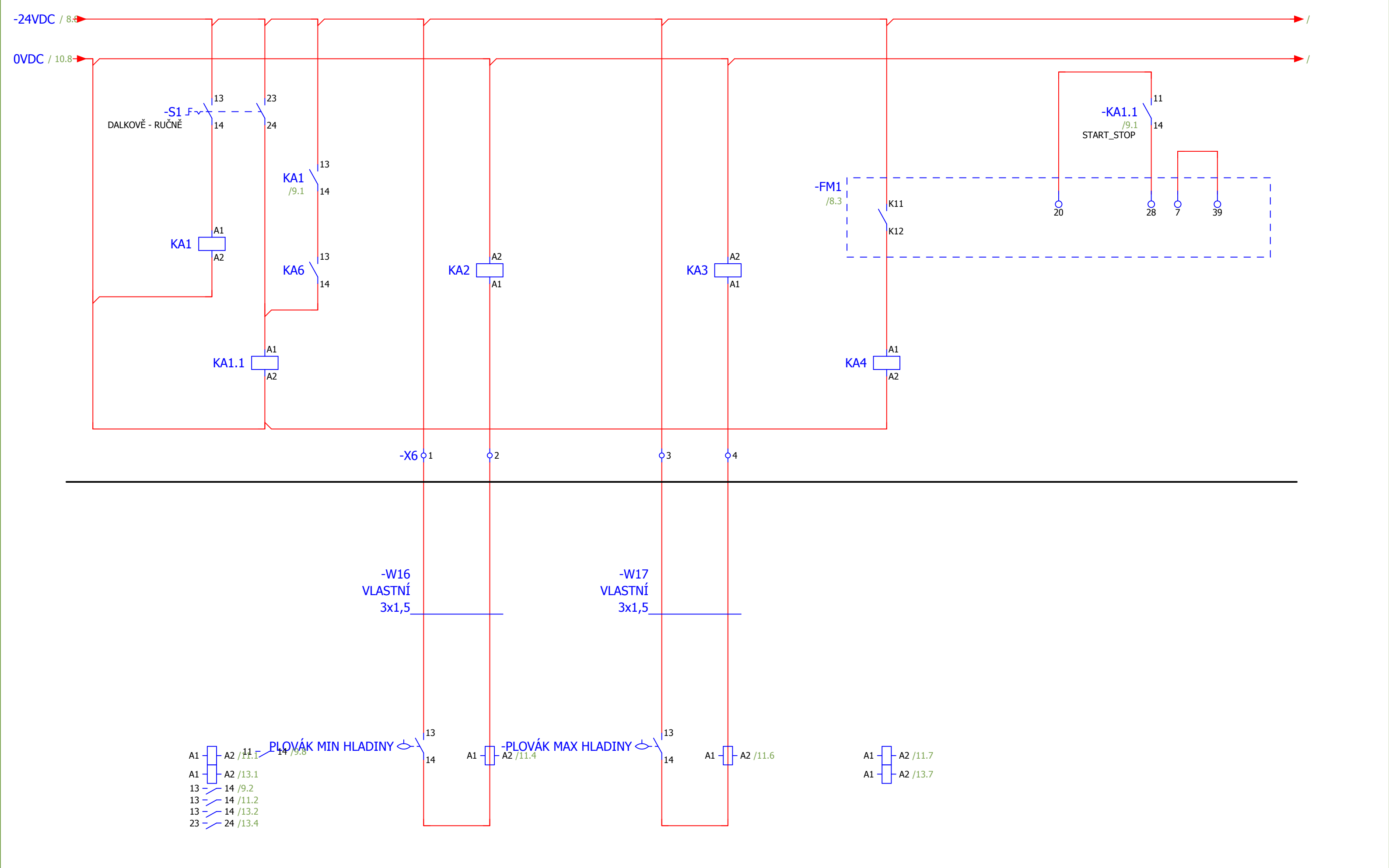

Datum	24.11.2014	ČOV LIBAVÁ	Náhrada z	Nahrazeno čím	ROZVADĚČ RM1_OVLADAČKA	=	+	List 9	List 29
Zprac..	Luděk								
Zkontr.									
Změna	Datum	Název	Pův.						

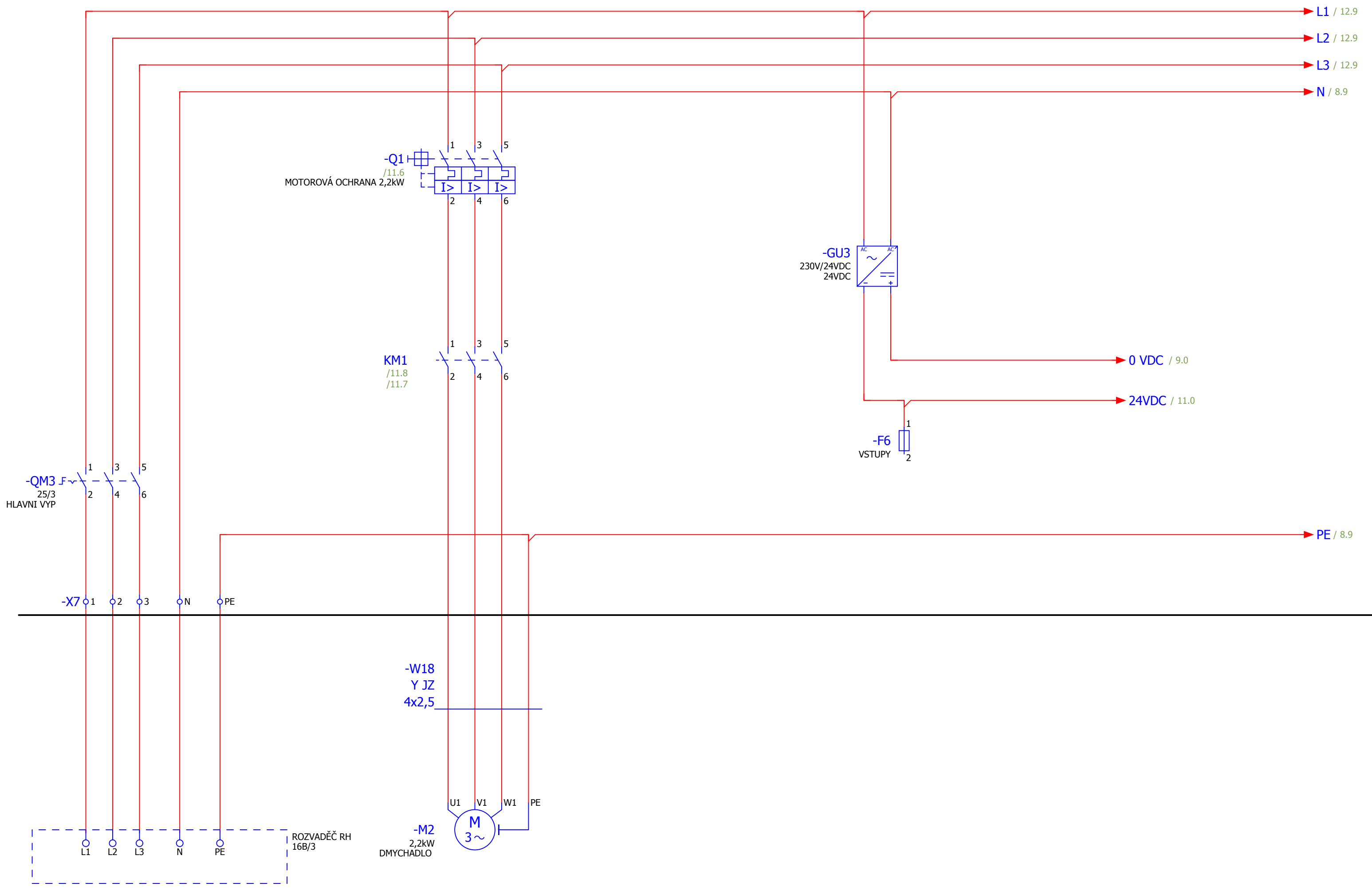

			Datum	24.11.2014					=
			Zprac..	Luděk					+
			Zkontr.		ČOV LIBAVÁ				
Změna	Datum	Název	Pův.		Náhrada z	Nahrazeno čím			List 10
									List 29

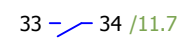
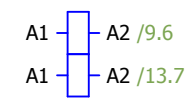
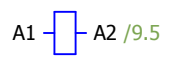
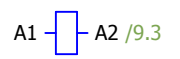
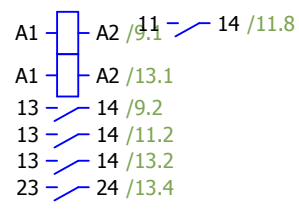
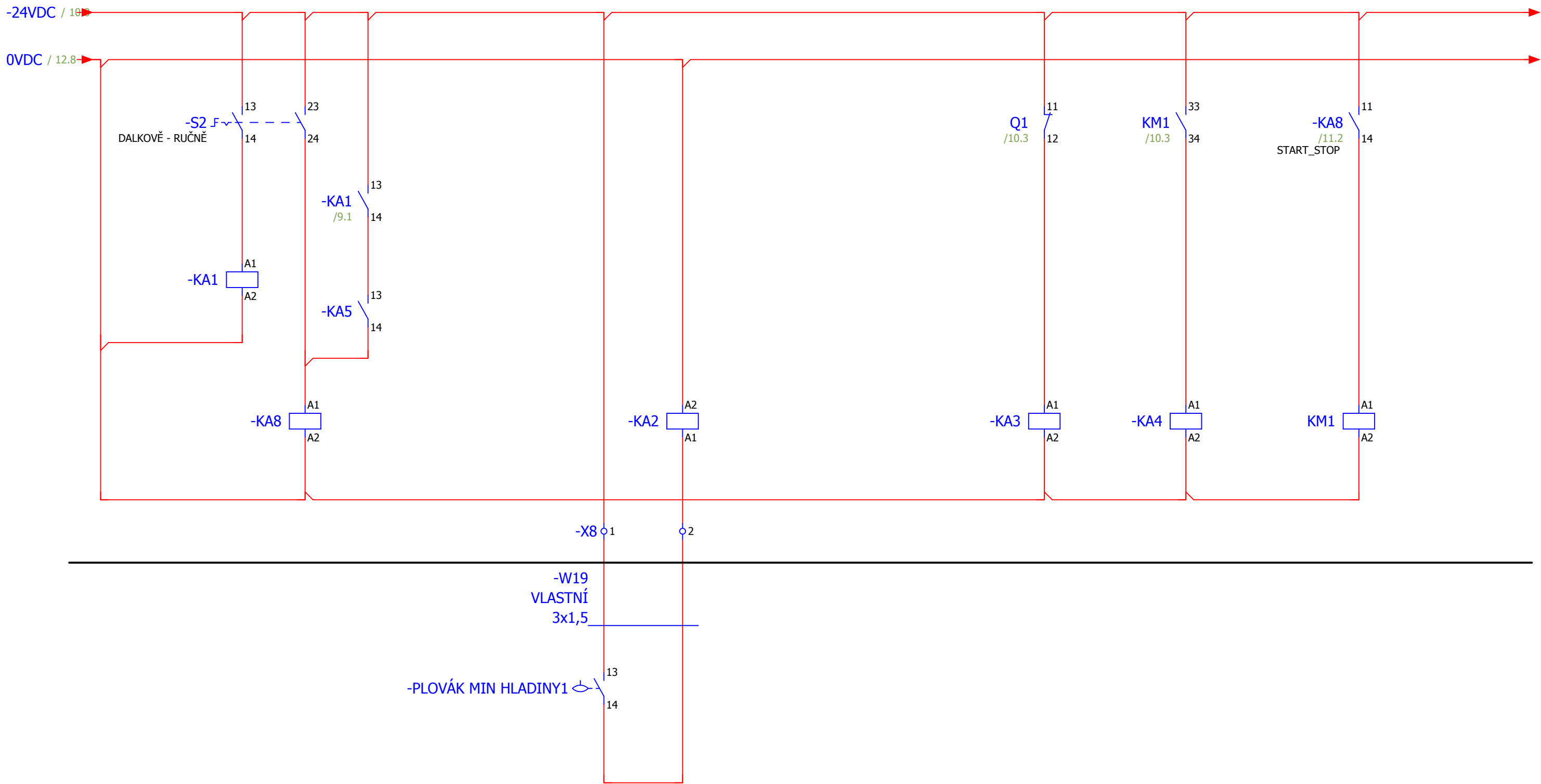

				Datum	24.11.2014					=	
				Zprac.	Luděk					+	
				Zkontr.		ČOV LIBAVÁ				List	11
Změna	Datum	Název	Pův.	Náhrada z	Nahrazeno čím					List	29

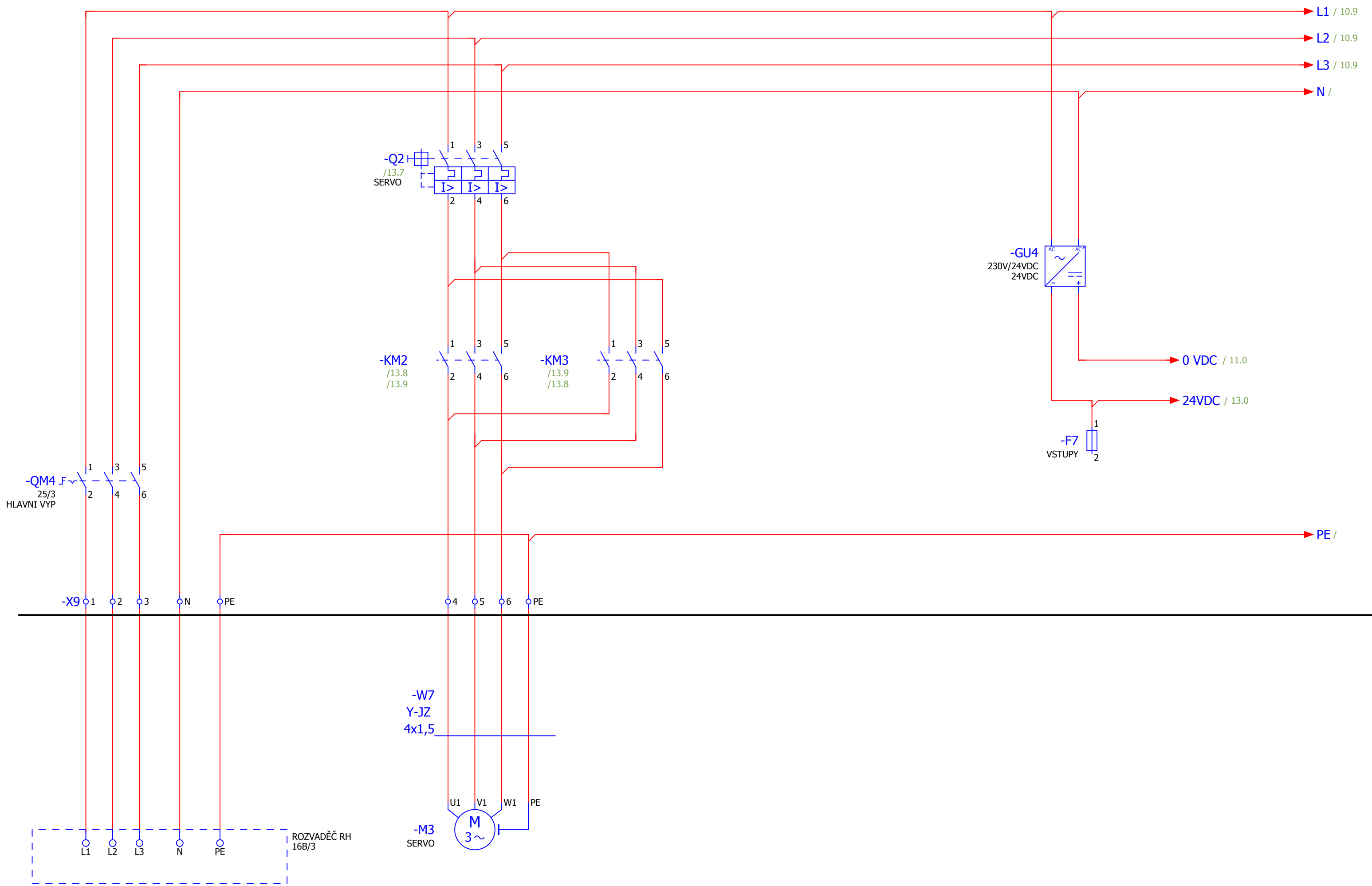

			Datum	24.11.2014					=
			Zprac.	Luděk					+
			Zkontr.		ČOV LIBAVÁ				List
Změna	Datum	Název	Pův.		Náhrada z	Nahrazeno čím			List
									29

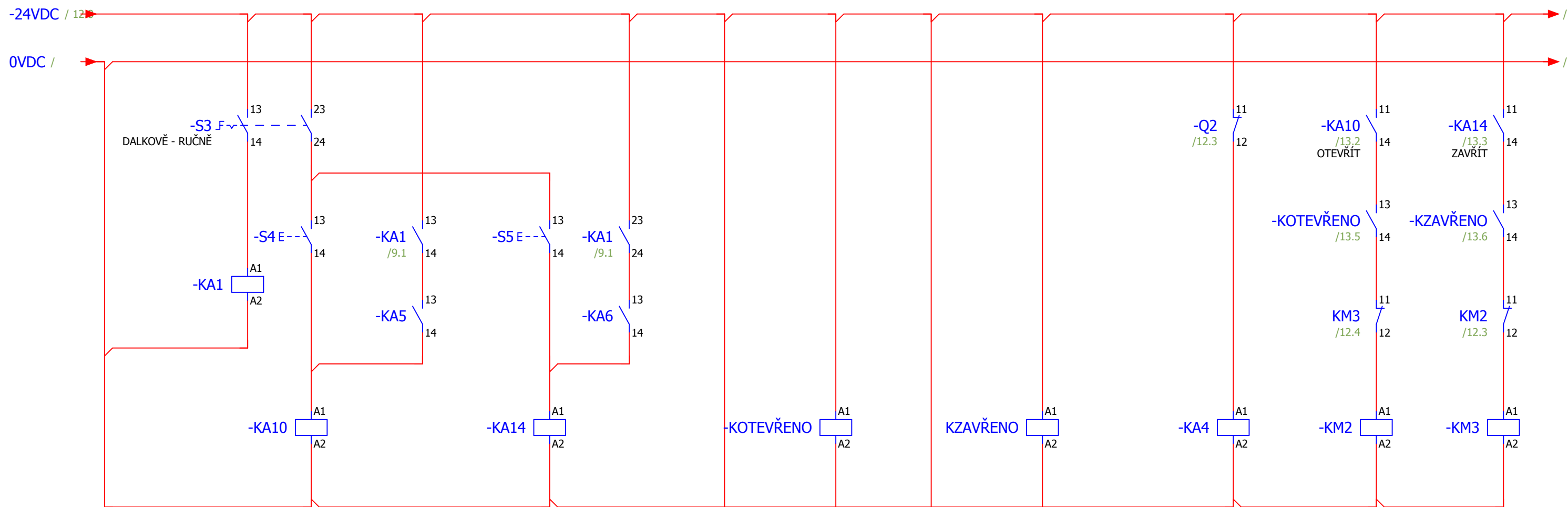

X9 7 8 9 10

-W20
CYKY
12x1

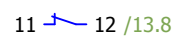
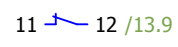
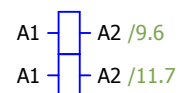
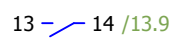
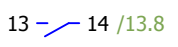
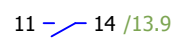
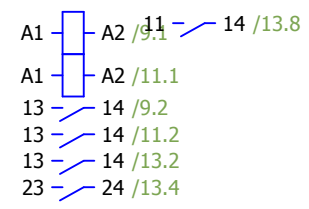
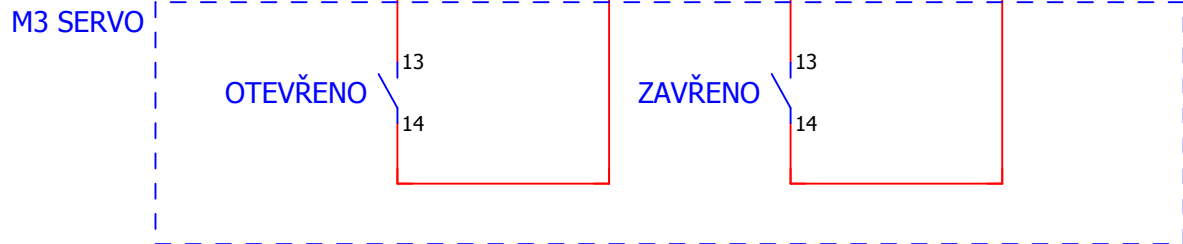

				Datum	24.11.2014			ROZVADĚČ RM3_OVLADAČKA		=	
				Zprac.	Luděk					+	
				Zkontr.		ČOV LIBAVÁ				List	13
Změna	Datum	Název	Pův.	Náhrada z	Nahrazeno čím					List	29

Plán kabelu

F09_001

Název kabelu =+-W1	Typ kabelu CYKY		Počet žil 5		Průřez 6	Délka kabelu		Funkční text
	Křížový odkaz	Označení cíle od	Napojení	Žíla	Označení cíle po	Napojení	Křížový odkaz	Funkční text
	/1.0	-X1	1			L1	/1.0	
	/1.1	-X1	PE			PE	/1.1	

Plán kabelu

Funkční text	Typ kabelu Y-JZ		Počet žil 4		Průřez 1,5	Délka kabelu		Funkční text
	Křížový odkaz	Označení cíle od	Napojení	Žíla		Označení cíle po	Napojení	
	/12.3	-X9	4		-M3	U1	/12.3	
	/12.3	-X9	5		-M3	V1	/12.3	
	/12.3	-X9	6		-M3	W1	/12.3	
	/12.3	-X9	PE		-M3	PE	/12.3	

		Datum	24.11.2014	ČOV LIBAVÁ	Plán kabelů =+-W7			=
		Zprac.	Luděk					+
Změna	Datum	Název	Pův.	Náhrada z	Nahrazeno čím			List 15
								List 29

Plán kabelu

F09_001

Název kabelu =+-W8	Typ kabelu CYKY		Počet žil 5		Průřez 2,5	Délka kabelu		Funkční text
	Funkční text	Křížový odkaz	Označení cíle od	Napojení	Žíla	Označení cíle po	Napojení	Křížový odkaz
	/1.4	-X1	4		-RM1	L1	/1.4	
	/1.4	-X1	5		-RM1	L2	/1.4	
	/1.4	-X1	6		-RM1	L3	/1.4	
	/1.4	-X1	N		-RM1	N	/1.4	
	/1.5	-X1	PE		-RM1	PE	/1.5	

Plán kabelu

Název kabelu =+-W9	Typ kabelu CYKY		Počet žil 5		Průřez 2,5	Délka kabelu		Funkční text
	Křížový odkaz	Označení cíle od	Napojení	Žíla	Označení cíle po	Napojení	Křížový odkaz	Funkční text
	/1.6	-X1	7		-RM2	L1	/1.6	
	/1.6	-X1	8		-RM2	L2	/1.6	
	/1.6	-X1	9		-RM2	L3	/1.6	
	/1.7	-X1	N		-RM2	N	/1.7	
	/1.7	-X1	PE		-RM2	PE	/1.7	

	Datum	24.11.2014			Plán kabelů =+-W9		=	
	Zprac.	Luděk					+	
	Zkontr.		ČOV LIBAVÁ					List 17
Změna	Datum	Název	Pův.	Náhrada z	Nahrazeno čím			List 29

Plán kabelu

F09_001

Název kabelu =+-W10	Typ kabelu CYKY		Počet žil 5		Průřez 2,5	Délka kabelu		Funkční text
	Křížový odkaz	Označení cíle od	Napojení	Žíla	Označení cíle po	Napojení	Křížový odkaz	Funkční text
	/1.8	-X1	10		-RM3	L1	/1.8	
	/1.8	-X1	11		-RM3	L2	/1.8	
	/1.8	-X1	12		-RM3	L3	/1.8	
	/1.9	-X1	N		-RM3	N	/1.9	
	/1.9	-X1	PE		-RM3	PE	/1.9	

		Datum	24.11.2014		ČOV LIBAVÁ	Plán kabelů =+-W10			List 18
		Zprac.	Luděk						
		Zkontr.							
Změna	Datum	Název	Pův.	Náhrada z	Nahrazeno čím				List 29

Plán kabelu

F09_001

Název kabelu =+-W11	Typ kabelu VLASTNÍ		Počet žil 3		Průřez 1,5	Délka kabelu		Funkční text
						Napojení	Křížový odkaz	Funkční text
Funkční text	Křížový odkaz	Označení cíle od	Napojení	Žíla	Označení cíle po	Napojení	Křížový odkaz	Funkční text
	/3.7	-RM1-X1	13		-TLAKOVÁ SONDA	1	/3.7	
	/3.8	-RM1-X1	14		-TLAKOVÁ SONDA	2	/3.8	

Datum	24.11.2014	ČOV LIBAVÁ	Náhrada z	Nahrazeno čím	Plán kabelů =+-W11	=	+	List 19	List 29
Zprac.	Luděk								
Zkontr.									
Změna	Datum	Název	Pův.						

Plán kabelu

F09_001

Název kabelu =+-W12	Typ kabelu CYKY		Počet žil 19		Průřez 1,5	Délka kabelu		Funkční text
	Funkční text	Křížový odkaz	Označení cíle od	Napojení	Žíla	Označení cíle po	Napojení	Křížový odkaz
	/3.1	-RM1-X1	1		-X2	1	/3.1	
	/3.1	-RM1-X1	2		-X2	2	/3.1	
	/3.2	-RM1-X1	3		-X2	3	/3.2	
	/3.2	-RM1-X1	4		-X2	4	/3.2	
	/3.3	-RM1-X1	5		-X2	5	/3.3	
	/3.3	-RM1-X1	6		-X2	6	/3.3	
	/3.4	-RM1-X1	7		-X2	7	/3.4	
	/3.4	-RM1-X1	8		-X2	8	/3.4	
	/3.5	-RM1-X1	9		-X2	9	/3.5	
	/3.5	-RM1-X1	10		-X2	10	/3.5	
	/3.6	-RM1-X1	11		-X2	11	/3.6	
	/3.7	-RM1-X1	12		-X2	12	/3.7	
	/3.7	-RM1-X1	13		-X2	13	/3.7	
	/3.8	-RM1-X1	14		-X2	14	/3.8	

Plán kabelu

F09_001

Název kabelu =+-W13		Typ kabelu CYKY		Počet žil 19		Průřez 1,5	Délka kabelu		Funkční text
Funkční text		Křížový odkaz	Označení cíle od	Napojení	Žíla	Označení cíle po	Napojení	Křížový odkaz	Funkční text
		/5.1	-RM2-X1	1		-X3	1	/5.1	
		/5.1	-RM2-X1	2		-X3	2	/5.1	
		/5.2	-RM2-X1	3		-X3	3	/5.2	
		/5.2	-RM2-X1	4		-X3	4	/5.2	
		/5.3	-RM2-X1	5		-X3	5	/5.3	
		/5.4	-RM2-X1	6		-X3	6	/5.4	
		/5.4	-RM2-X1	7		-X3	7	/5.4	
		/5.5	-RM2-X1	8		-X3	8	/5.5	
		/5.7	-RM2-X1	9		-X3	11	/5.7	
		/5.7	-RM2-X1	10		-X3	12	/5.7	

Plán kabelu

F09_001

Název kabelu =+-W16	Typ kabelu VLASTNÍ		Počet žil 3		Průřez 1,5	Délka kabelu		Funkční text
	Funkční text	Křížový odkaz	Označení cíle od	Napojení	Žíla	Označení cíle po	Napojení	Křížový odkaz
	/9.3	-X6	1		-PLOVÁK MIN HLADINY	13	/9.3	
	/9.3	-X6	2		-PLOVÁK MIN HLADINY	14	/9.3	

	Datum	24.11.2014		ČOV LIBAVÁ	Plán kabelů =+-W16	=	
	Zprac..	Luděk				+	
Změna	Datum	Název	Pův.			Náhrada z	Nahrazeno čím
						List	29

Plán kabelu

F09_001

Název kabelu =+-W17	Typ kabelu VLASTNÍ		Počet žil 3		Průřez 1,5	Délka kabelu		Funkční text	
	Funkční text	Křížový odkaz	Označení cíle od	Napojení	Žíla	Označení cíle po	Napojení	Křížový odkaz	Funkční text
	/9.4	-X6	3			-PLOVÁK MAX HLADINY	13	/9.4	
	/9.5	-X6	4			-PLOVÁK MAX HLADINY	14	/9.4	

			Datum	24.11.2014			Plán kabelů =+-W17		=	
			Zprac.	Luděk					+	
			Zkontr.		ČOV LIBAVÁ					List 25
Změna	Datum	Název	Pův.		Náhrada z	Nahrazeno čím				List 29

Plán kabelu

F09_001

Název kabelu =+-W18	Typ kabelu Y JZ		Počet žil 4		Průřez 2,5	Délka kabelu		Funkční text
	Funkční text	Křížový odkaz	Označení cíle od	Napojení		Žíla	Označení cíle po	
	/8.3	-FM1	PE		-M2	PE	/10.3	2,2kW
	/10.1	-X7	PE		-M2	PE	/10.3	=
	/10.3	-KM1	2		-M2	U1	/10.3	=
	/10.3	-KM1	4		-M2	V1	/10.3	=
	/10.3	-KM1	6		-M2	W1	/10.3	=

Plán kabelu

F09_001

Název kabelu =+-W19	Typ kabelu VLASTNÍ		Počet žil 3		Průřez 1,5	Délka kabelu		Funkční text	
	Funkční text	Křížový odkaz	Označení cíle od	Napojení	Žíla	Označení cíle po	Napojení	Křížový odkaz	Funkční text
	/11.3	-X8	1			-PLOVÁK MIN HLADINY1	13	/11.3	
	/11.4	-X8	2			-PLOVÁK MIN HLADINY1	14	/11.3	

			Datum	24.11.2014	ČOV LIBAVÁ	Plán kabelů =+-W19			=							
			Zprac.	Luděk						Náhrada z	Nahrazeno čím			+		
			Zkontr.												List	27
Změna	Datum	Název	Pův.													

Plán kabelu

F09_001

Název kabelu =+-W20	Typ kabelu CYKY		Počet žil 12		Průřez 1	Délka kabelu		Funkční text
	Křížový odkaz	Označení cíle od	Napojení	Žíla	Označení cíle po	Napojení	Křížový odkaz	Funkční text
	/13.4	-X9	7		-M3 SERVO-OTEVŘENO	13	/13.4	
	/13.5	-X9	8		-M3 SERVO-OTEVŘENO	14	/13.4	
	/13.5	-X9	9		-M3 SERVO-ZAVŘENO	13	/13.5	
	/13.6	-X9	10		-M3 SERVO-ZAVŘENO	14	/13.5	

Datum	24.11.2014	ČOV LIBAVÁ	Plán kabelů =+-W20		=
Zprac.	Luděk				+
Zkontr.		Náhrada z	Nahrazeno čím		List 28
Změna	Datum	Název	Pův.		List 29